

### M-bus Level converter 60

WTV531-GA5060



**The level converter WTV531-GA5060 is an interface between M-bus meters and reader systems. PC software ACT531 reads the data locally or via the Internet using an optional web server.**

- Connect up to 60 M-bus devices (max. 60 simple M-bus loads)
- Use up to six level converters on one M-bus network with a max. of 360 simple M-bus loads
- Local data read out with the ACT531 PC software via USB or the RS-232 interface
- Remote read out via M-bus web server
- Local data read out via a PXC device via the RS-232 interface
- Reads a max. 1,000 logical devices on a level converter network
- Supply voltage AC/DC 24 V

The level converter is the communications interface to read up to 60 M-bus devices (simple M-bus loads).

The data is read out:

- Locally with the ACT531 PC software via USB
- Locally with the ACT531 PC software via the RS-232 interface
- Via the M-bus web server WTV534..., WTV676..
- Via Desigo CC

Up to six level converters can be connected in parallel to a M-bus web server WTV676.. (Master) on a M-bus network.

Up to 60 M-bus devices can be connected to each level converter WTV531... The level converter can be used:

- As individual components on a M-bus network.
- To extend a M-bus network by up to six level converters connected in parallel.

You can also use the level converter at your own risk as an interface to suitable software and devices by third-party manufacturers.

The level converter is protected against short circuits.



**NOTICE**

We recommend using a DC 24 V power supply to ensure a stable signal.

Operating modes

The data can be read in different ways.

**Local data read out with the ACT531 software via the USB connection**

The level converter is used as the communication interface between M-bus devices and a laptop using the ACT531 software. The ACT531 software can read a max. of 1,000 logical devices.

The level converter is operated as the master. The data is read locally via the USB connection.

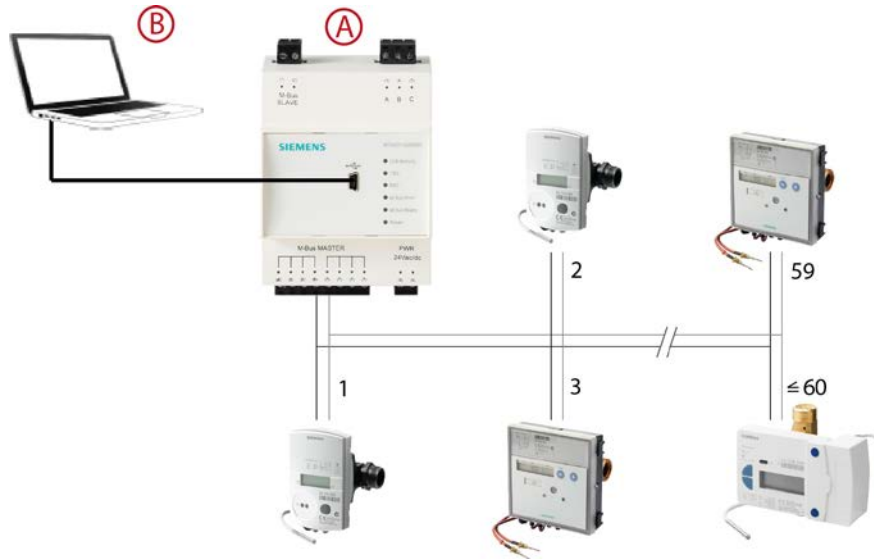

- A Level converter as master
- B Laptop with ACT531 software

**Local data read out using the ACT531 PC software via the RS-232 interface**

The level converter can also be connected to a laptop via a RS-232 interface.

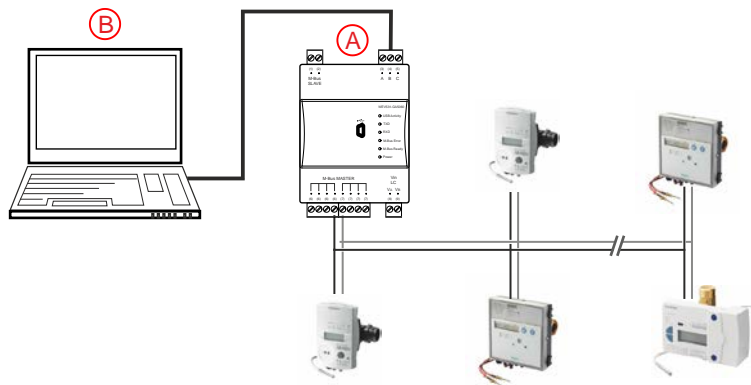

- A Level converter as master
- B Laptop with ACT531 software

### Remote read out via M-bus web server

The level converter is used as the communication interface between M-bus devices and a M-bus web server.

The master level converter WTV531(A) is connected to a M-bus web server WTV676.. via the RS-232 interface (terminals A, B, C).

The following slave level converters (B) can be connected via the M-bus slave connection. The data can be read via the web server from anywhere on the Internet.

A maximum of 250 devices can be read via M-bus web server WTV676...

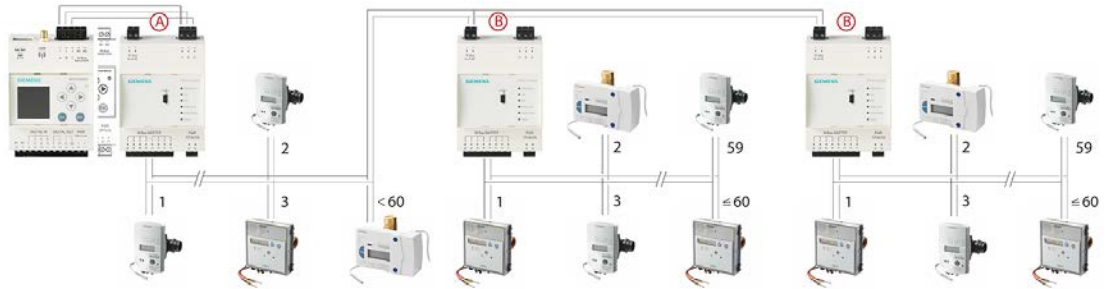

A Level converter as master

B Level converter as slave



### NOTICE

The level converter is connected as a slave (B) to the web server (A) (terminals M1M2 of the web server) if the firmware version of the web server WTV676.. is less than SIE.WTV676\_WI-2.29\_FW-3.0-17-2.6.

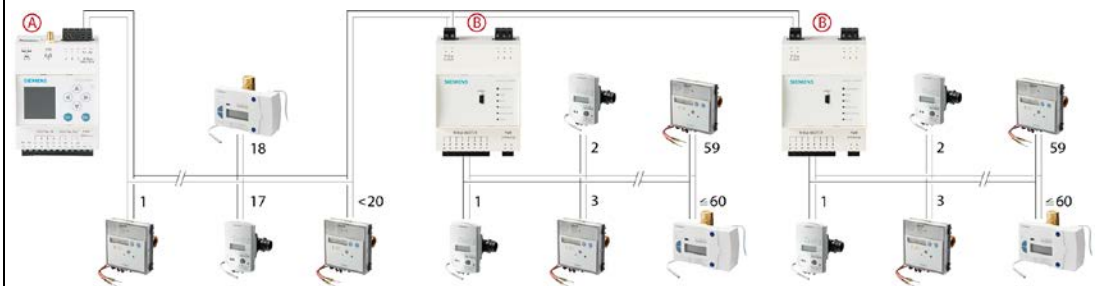

### Local data read out with Desigo CC via the RS-232 interface

The TX Open module integrates M-bus devices via a RS-232 interface to the Desigo CC building management platform.

Additional information on the Desigo CC management platform is available in the engineering guide 'Desigo TM TX Open, TX M-bus', document CM110572. See Section "Product documentation [→ 12]".

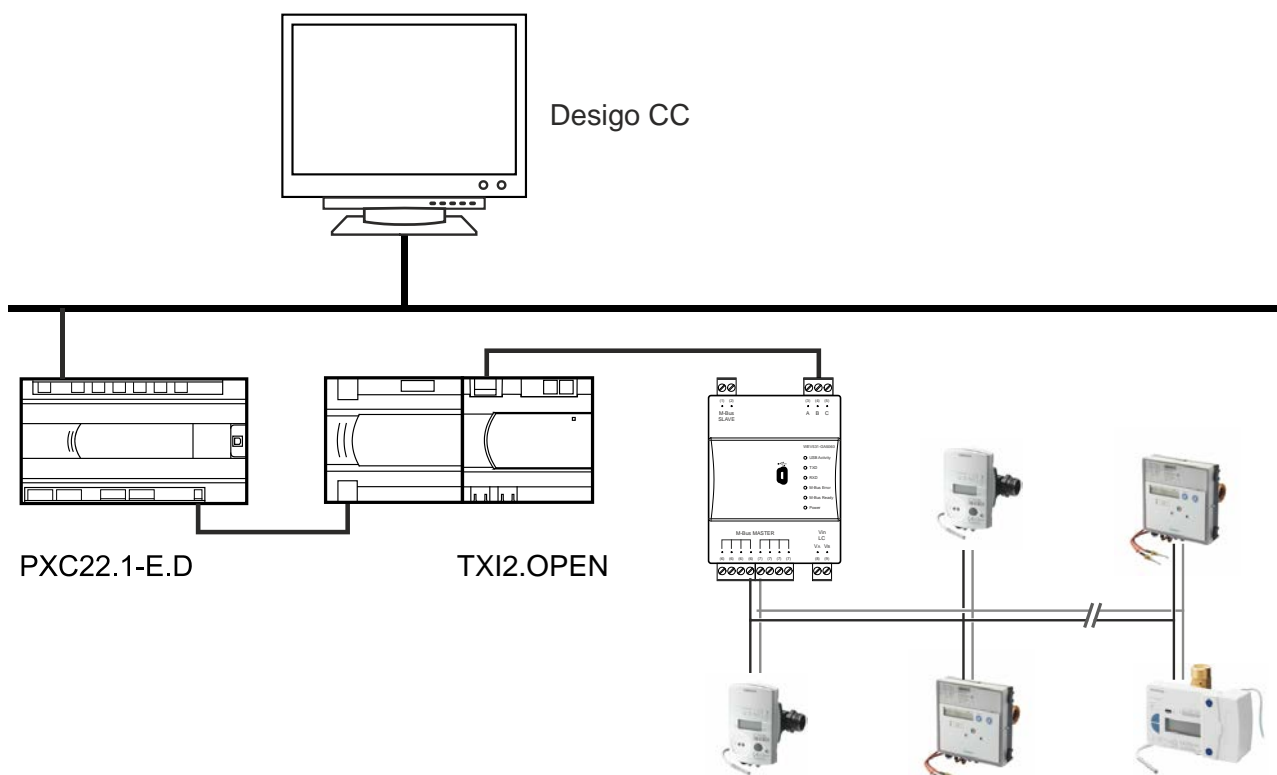

The level converter can be used in various ways.

Up to 60 M-bus devices can be connected to each level converter WTV531...

### Level converter as individual component

The level converter can be used as an individual component on one M-bus network with up to 60 devices.

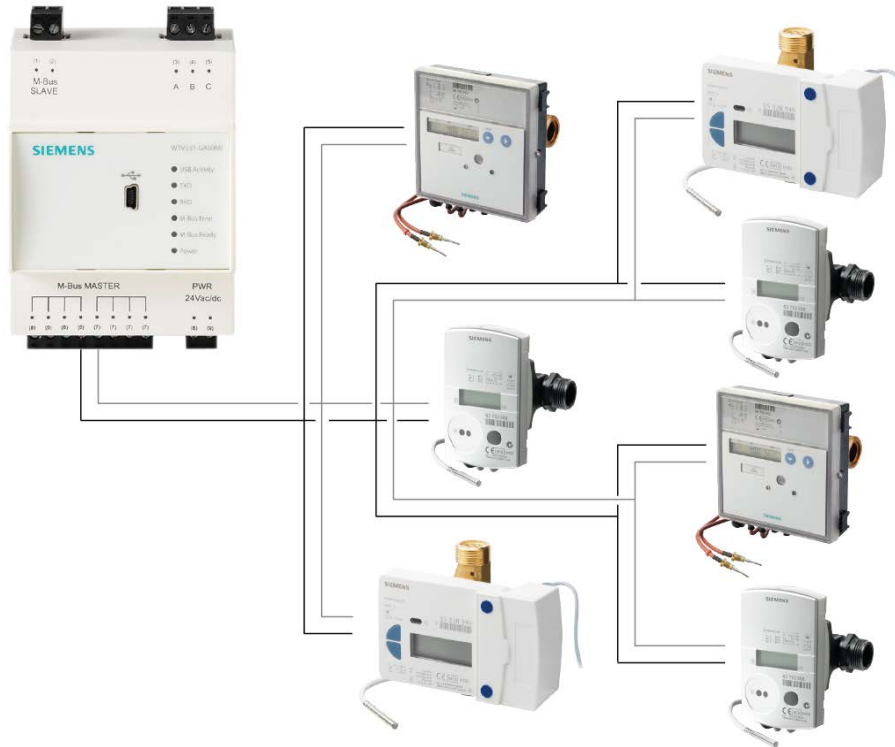

### Level converter to extend a M-bus network

The level converter extends a M-bus network with up to six level converters connected in parallel.

It is connected with a serial connection to the master level converter and in parallel to other level converters.

A maximum of six level converters can be integrated in parallel and connected to a M-bus web server WTV676... A maximum of five level converters can be connected in parallel to a master level converter WTV531.

A maximum of 360 M-bus loads or 1,000 logical devices can be read via the master level converter.

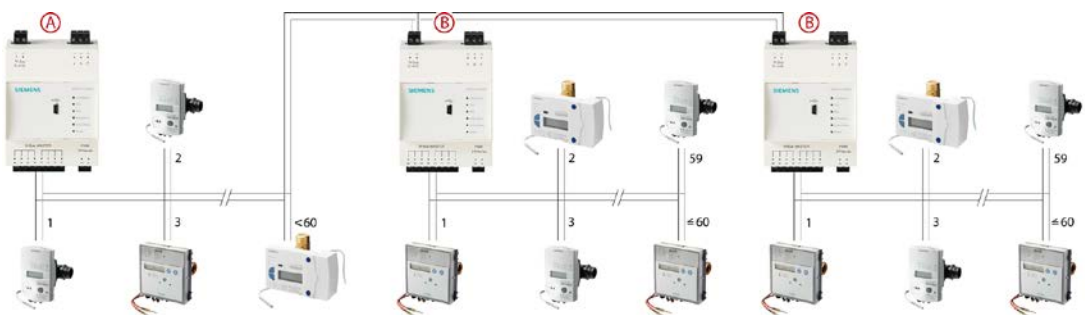

A Level converter as master

B Level converter as slave

## Indicators

---

- USBActivity    The level converter has six LEDs on the front side for indicating the operating state.
- TXD
- RXD
- M-Bus Error
- M-Bus Ready
- Power

### **USB activity**

The LED indicates the USB interface connection state.

- Flashes 2 x -> The device is ready to connect to a PC using a mini USB-B cable.
- Flashes 5 x -> The device is connected to a PC and correctly recognized by it.

### **TXD**

The LED indicates the transmission state on the M-bus master (terminals 6 and 7).

- On -> Data transmitting.
- Off -> No data transmission.

### **RXD**

The LED indicates the receive state on the M-bus master (terminals 6 and 7).

- On -> Data is being received.
- Off -> No data is being received.

### **M-bus error**

The LED indicates the state of the M-bus power supply.

- On -> Bus overload. (short circuit or too many devices on the bus).
- Off -> No faults recognized.

### **M-bus ready**

The LED indicates that bus power is correct and there are no anomalies.

- On -> Bus power is properly polled and sufficient for trouble-free operation.
- Off -> Bus power is insufficient for trouble-free operation.

### **Power**

The LED indicates the state of the level converter power supply.

- On -> The device power supply is correct.
- Off -> Device power is not correct or unavailable.

### Topology

The M-bus permits various network topologies. The devices can be connected to the level converter in a line, bus, star, or tree topology, or a combination thereof.

Ring topology is not permitted.

Bus cable polarity is not relevant, simplifying installation.

**Line topology**



**Bus topology**



**Star topology**



**Tree topology**





### Combination of topologies

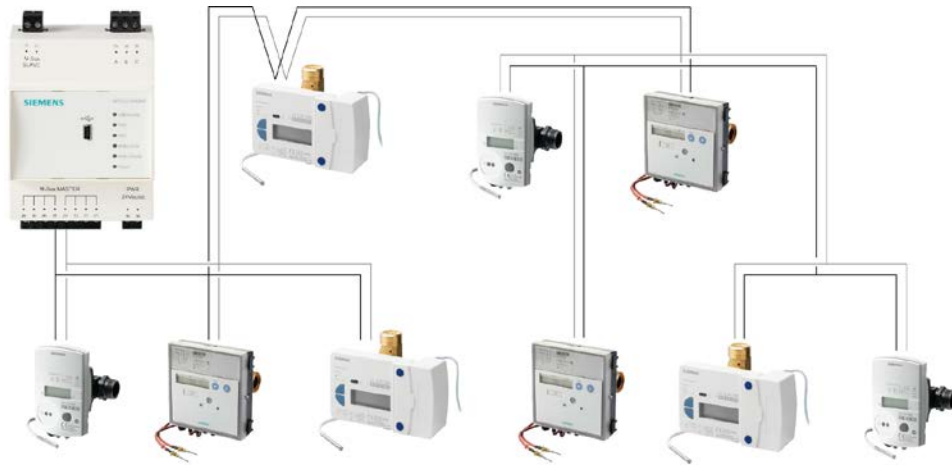

### Ring topology



**Address**

M-bus uses two types of addresses to recognize devices:

- Primary addressing: Up to 250 primary addresses can be assigned to a M-bus system. The primary address is normally assigned during device commissioning. Pure primary addressing is not possible if more than 250 devices are read.
- Secondary addressing: Secondary addressing consists of 8 bytes and permits the assignment of any number. In the default setting, the secondary address for a device normally matches the serial number issued by the device manufacturer. The assignment prevents address conflicts on the bus.

**Bus expansion**

| Plant type                  | Maximum distance | Total cable length | Cable cross section | Number of devices (slaves) | Max. transmission rate |
|-----------------------------|------------------|--------------------|---------------------|----------------------------|------------------------|
| Small residential buildings | 350 m            | 1000 m             | 0.8 mm <sup>2</sup> | 250                        | 9600 baud              |
| Large residential buildings | 350 m            | 4000 m             | 0.8 mm <sup>2</sup> | 250                        | 2400 baud              |
|                             |                  |                    |                     | 64                         | 9600 baud              |
| Small developments          | 1000 m           | 4000 m             | 0.8 mm <sup>2</sup> | 64                         | 2400 baud              |
| Large developments          | 3000 m*          | 5000 m             | 1.5 mm <sup>2</sup> | 64                         | 2400 baud              |
| Direct vicinity             | 5000 m*          | 7000 m             | 1.5 mm <sup>2</sup> | 16                         | 300 baud               |
| Point-to-point connection   | 10000 m*         | 10000 m            | 1.5 mm <sup>2</sup> | 1                          | 300 baud               |

\*Shielded cabling required at a distance in excess of 1,000 m (see EN13757-2 appendix E).

**Signal specification**

| M-bus                                 | Condition                     | Minimum | Typical | Maximum | Measuring unit |
|---------------------------------------|-------------------------------|---------|---------|---------|----------------|
| Number simple M-bus loads per segment | WTV531-GA5060                 | 0       |         | 60      |                |
| Transfer rate                         | C <sub>Segment</sub> ≤ 382 nF | 300     | 2400    | 9600    | baud           |
| Bus power (Master)                    | WTV531-GA5060                 | 30      | 39      | 40      | R              |
| Bus current (master)                  | WTV531-GA5060                 | 0       |         | 90      | mA             |

## Connection terminals

The device as the following connection terminals / LEDs.

|  |                                                                                                                                                                                                         |
|--|---------------------------------------------------------------------------------------------------------------------------------------------------------------------------------------------------------|
|  | <p>A Power supply AC/DC 24 V<br/>Terminals (8) and (9)</p>                                                                                                                                              |
|  | <p>B Connections for M-bus meters and<br/>Connections for following level converters, if this one is used as the master.<br/>Terminals (6) and (7)</p>                                                  |
|  | <p>C Non-isolated connections to connect to a M-bus web server and / or<br/>Connections to connect the prior level converter, if this level converter is used as a slave.<br/>Terminals (1) and (2)</p> |
|  | <p>D Isolated serial interface RS232 to connect to a laptop or M-bus master<br/>A = TX<br/>B = RX<br/>C = GND<br/>Terminals (3), (4) and (5)</p>                                                        |
|  | <p>E Laptop connection<br/>Mini-USB-B</p>                                                                                                                                                               |
|  | <p>F LEDs</p>                                                                                                                                                                                           |

## Type summary

### Order information

| Description                                           | Order number | Type          |
|-------------------------------------------------------|--------------|---------------|
| Level converter to power a max. 60 simple M-bus loads | S55563-F145  | WTV531-GA5060 |

### Product inserts

Mounting instructions for the level converter are included in the following languages: Bulgarian, German, English, Finnish, French, Greek, Italian, Croatian, Lithuanian, Dutch, Norwegian, Polish, Slovakian, Slovenian, Spanish, Czech, Turkish, and Hungarian.

### Equipment combinations

The following products are available for reading data:

| Description                                                 | Order number | Type          |
|-------------------------------------------------------------|--------------|---------------|
| M-bus web server for remote meter data reading              | S55563-F144  | WTV534-0B4022 |
| M-bus web server for remote meter data reading              | S55563-F150  | WTV676-HB6035 |
| Read software for local data reading at the level converter | ---          | ACT531        |

### Product documentation

| Topic                                                       | Title                                                                                                                                                 | Document ID |
|-------------------------------------------------------------|-------------------------------------------------------------------------------------------------------------------------------------------------------|-------------|
| Device mounting, wiring, connecting peripheral devices.     | Mounting instructions, level converter WTV531..                                                                                                       | A6V10844308 |
| Engineering, commissioning, operation, and troubleshooting. | User manual level converter WTV531.. and Web Server WTV534..                                                                                          | A6V10844341 |
| Engineering, commissioning, operation, and troubleshooting  | User's guide M-bus web server WTV676-HB6035, M-bus level converter WTX631-GA0090<br>M-bus level converter WTV531-GA5060<br>RF converter WTX660-E05060 | A6V11157985 |
| Engineering instructions                                    | Desigo TM TX Open, TX M-bus                                                                                                                           | CM110572    |



Related documents such as environmental declarations, CE declarations, etc., can be downloaded at the following Internet address:

<http://siemens.com/bt/download>

## Safety

|                                                                                   |                                                                                                                                                                                                                                                                               |
|-----------------------------------------------------------------------------------|-------------------------------------------------------------------------------------------------------------------------------------------------------------------------------------------------------------------------------------------------------------------------------|
|  | <b>⚠ CAUTION</b>                                                                                                                                                                                                                                                              |
|                                                                                   | <b>National safety regulations</b><br>Failure to comply with national safety regulations may result in personal injury and property damage. <ul style="list-style-type: none"><li>• Observe national provisions and comply with the appropriate safety regulations.</li></ul> |

## Disposal

|                                                                                                                                                                        |                                                                                                                                                                                                                                                                                                                                                          |
|------------------------------------------------------------------------------------------------------------------------------------------------------------------------|----------------------------------------------------------------------------------------------------------------------------------------------------------------------------------------------------------------------------------------------------------------------------------------------------------------------------------------------------------|
| <br> | The device is considered an electronic device for disposal in accordance with the European Guidelines and may not be disposed of as domestic garbage. <ul style="list-style-type: none"><li>• Dispose of the device through channels provided for this purpose.</li><li>• Comply with all local and currently applicable laws and regulations.</li></ul> |
|------------------------------------------------------------------------------------------------------------------------------------------------------------------------|----------------------------------------------------------------------------------------------------------------------------------------------------------------------------------------------------------------------------------------------------------------------------------------------------------------------------------------------------------|

## Warranty service

Technical data on specific applications are valid only together with Siemens products listed under "Equipment combinations". Siemens rejects any and all warranties in the event that third-party products are used.

## Technical data

| Power supply              |                                                    |                                      |
|---------------------------|----------------------------------------------------|--------------------------------------|
| Operating voltage         | AC/DC 24 V +/- 10 %                                |                                      |
| AC frequency              | 50/60 Hz                                           |                                      |
| Power consumption         | 3 W + 0.07 W for each connected M-bus device       |                                      |
| Maximum power consumption | 12 W, 12 VA                                        |                                      |
| Internal fuse             | PTC resistance and varistor                        |                                      |
| Fusing of supply lines    | Fusible links                                      | Max. 10 A, slow                      |
|                           | Circuit breaker                                    | max. 13 A, type B, C, D per EN 60898 |
|                           | or<br>Power supply with current limitation at 10 A |                                      |

| Pins                             |                                                                                                                                                                     |
|----------------------------------|---------------------------------------------------------------------------------------------------------------------------------------------------------------------|
| M-bus master (terminals 6 and 7) | Connections for M-bus meters and<br>Connections for following level converters, if this one is used as the master.                                                  |
| M-bus slave (terminals 1 and 2)  | Non-isolated connections to connect to a M-bus web server and / or<br>Connections to connect the prior level converter, if this level converter is used as a slave. |
| Mini-USB-B                       | To connect to a laptop with installed ACT531 software                                                                                                               |

| Interface |                                                                                                                                                                                                                                                                                                                       |
|-----------|-----------------------------------------------------------------------------------------------------------------------------------------------------------------------------------------------------------------------------------------------------------------------------------------------------------------------|
| USB (2.0) | Non-isolated plug: Mini-USB-B<br>Data rate: 1.5 Mbps and 12 Mbps.<br>Max. cable length: 3 m                                                                                                                                                                                                                           |
| RS-232    | Galvanically isolated connection with a laptop/data logger<br>Max. cable length: 3 m <ul style="list-style-type: none"> <li>Terminal 3 [A]: TX laptop/data logger receiving line</li> <li>Terminal 4 [B]: RX laptop/data logger transmission line</li> <li>Terminal 5 [C]: GND interface reference voltage</li> </ul> |

| M-bus                                                    |                                                                                                                                                        |
|----------------------------------------------------------|--------------------------------------------------------------------------------------------------------------------------------------------------------|
| Reference standard                                       | EN13757-2 (physical layer)                                                                                                                             |
| Baud rate                                                | 300 bps...9600 bps                                                                                                                                     |
| M-bus USB insulation                                     | 1kV AC                                                                                                                                                 |
| Max. number of M-bus devices per level converter         | 60 (simple M-bus loads)                                                                                                                                |
| Max. number of M-bus devices per level converter network | 360 simple M-bus loads or 1,000 logical M-bus meters                                                                                                   |
| Max. number of level converters per network              | 1 master level converter and 5 slave level converters connected in parallel or 6 level converters connected in parallel to a M-bus web server WTV676.. |
| Bus power                                                | Minimum 30 V<br>Maximum 40 V                                                                                                                           |
| Bus current                                              | Maximum 90 mA                                                                                                                                          |
| Protection against short circuits                        | Yes                                                                                                                                                    |

| <b>Directives and standards</b> |                                                       |
|---------------------------------|-------------------------------------------------------|
| Product standards               | EN 62368-1<br>Information Technology Equipment Safety |
| Electromagnetic compatibility   | For residential and industrial environments           |
| EU conformity (CE)              | A5W00022156 *)                                        |

| <b>Environmental compatibility</b>                                                                                                                                                                                    |  |
|-----------------------------------------------------------------------------------------------------------------------------------------------------------------------------------------------------------------------|--|
| The product environmental declaration A6V10922887 *) contains data on environmentally compatible product design and assessments (RoHS compliance, materials composition, packaging, environmental benefit, disposal). |  |
| *) Documents can be downloaded at <a href="http://siemens.com/bt/download">http://siemens.com/bt/download</a> .                                                                                                       |  |

| <b>Degree of protection</b> |                       |
|-----------------------------|-----------------------|
| IP class                    | IP20 per EN60529      |
| Protection class            | III as per EN 62368-1 |

| <b>Ambient conditions</b> |                     |
|---------------------------|---------------------|
| <b>Operation</b>          | as per EN 60721-3-3 |
| Climatic conditions       | Class 3K5           |
| Temperature               | -10...+55° C        |
| Air humidity              | 5...95 % r.h.       |
| Mechanical conditions     | Class 3M2           |
| <b>Transportation</b>     | as per EN 60721-3-2 |
| Climatic conditions       | Class 2K3           |
| Temperature               | -25...+65 °C        |
| Air humidity              | 5...95 %            |
| Mechanical conditions     | Class 2M2           |
| <b>Storage</b>            | as per EN 60721-3-1 |
| Climatic conditions       | Class 1K3           |
| Temperature               | -25...+65 °C        |
| Air humidity              | 5...95 %            |
| Mechanical conditions     | Class 1M2           |

| <b>Materials and colors</b> |                            |
|-----------------------------|----------------------------|
| Housing                     | PC + ASA, RAL 9010 (white) |

| <b>Dimensions</b>       |                                    |
|-------------------------|------------------------------------|
| Length x Width x Height | 110x71x62 mm (including terminals) |

| <b>Weight</b>                              |          |
|--------------------------------------------|----------|
| Level converter with mounting instructions | 0.166 kg |
| Packaging                                  | 0.055 kg |

| <b>Mounting</b> |                             |
|-----------------|-----------------------------|
| Mounting type   | On 35mm DIN rails (EN60715) |

## Dimensions

